



www.freeshark.it

**Jacket MAX
Inflator In-Out
con Octopus**

**MAX Jacket
In-Out inflator
with Octopus**

art. 30013

**Jacket MAX
MAX Jacket**

art. 30012



jacket MAX

jacket MAX

- Bisacco gonfiabile in Platilon • Esterno in rete intrecciata ad alta resistenza
 - Schienalino morbido
- Elastico di regolazione per assetto gonfiabile
- Tasche portapiombi estraibili per 12,000 Kg.
- Inflator In-Out con Octopus
 - Disponibile nelle taglie S - M - L - XL - XXL e nella gamma di colori fotografati

**Ganfiabili MAX
sternali**
art. 300140

MAX jacket

- *Platilon twin-sack inflatable lifejacket*
- *Exterior in highly resistant woven netting*
 - *Soft back*
- *Elasticated strap for jacket adjustment*
- *Removable lead weight pockets, 12 Kg. capacity*
- *In-Out inflator with Octopus*
- *Available in sizes S - M - L - XL - XXL in the colours shown.*



ART.30010 JACKET HI PRO MAX

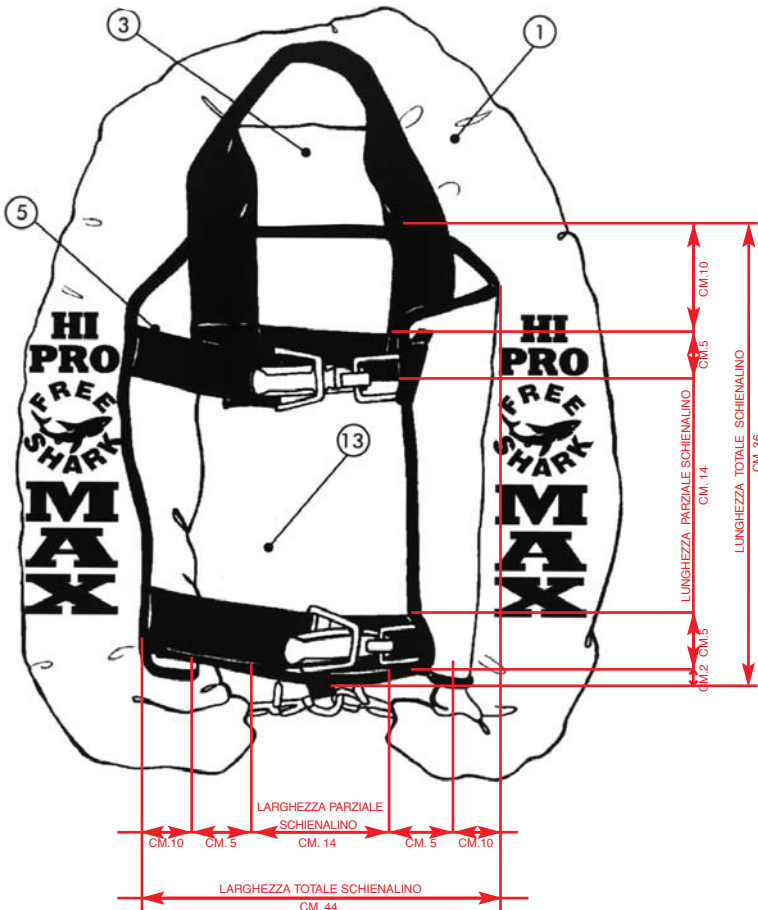
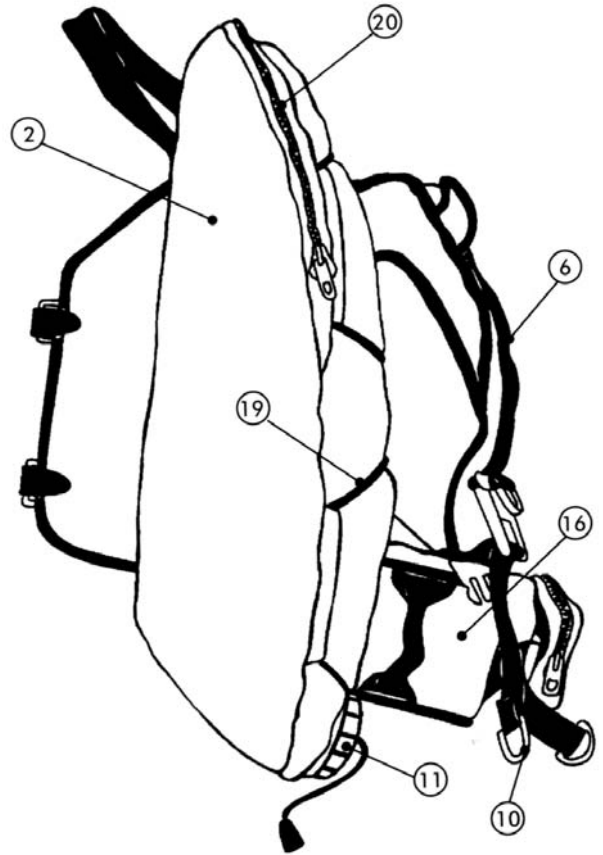

DESCRIZIONE	COMPOSIZIONE
1) GONFIABILE IN POLIURETANO	PLATILON UF7 MM. 0,350
2) CONTENITORE IN RETE	
3) SCHIENALINO	CORDIPOL + ELASTOLEN MM.5 + RETE IN PVC
4) PATTINE IN RETE	RETE IN PVC C/TRATTAMENTO SPECIALE
5) CINTURA C/MOSCHETTONI PER BLOCCAGGIO BOMBOLA	NASTRO TUBICO MM. 50 X 2,5 MOSCHETTONI IN ACCIAIO INOX
6) CINTURA C/FASTER MM. 40	NASTRO TUBICO MM. 40 X 1,5 PER SPALLAGGIO FASTER MM. 40 IN ACETALICA NERO (M+F)
7) CINTURA VENTRALE C/FASTER	NASTRO TUBICO MM. 40 X 1,5 FASTER MM. 25 IN ACETALICA NERO (M+F)
8) FASCIA VENTRALE C/VELCRO SU ESTREM.	VELCRO MM. 100 (ASOLA + UNCINO) CORDURA N. 10 CM. FASCIA MM. 3 X 9 DI ELASTOLEN/N
9) ANELLO A "D" PER REGOLAZIONE CINTURINI VENTRALI	ACETALICA NERO
10) ANELLI A "D" PER TIRAGGIO SPALLACCI	ACETALICA NERO MM.40
11) VALVOLA DI SOVRAPRESSIONE	
12) INFLATOR IN-OUT	
13) INTERNO IN CORDIPOL TRATTATO RESINATO	
14) INFLATOR IN-OUT C/OCTOPUS NEW NEO-R	
15/a) FRUSTA A BASSA PRESSIONE PER OCTOPUS	
15/b) FRUSTA A BASSA PRESSIONE PER JACKET	
16) TASCHE PORTA PIOMBI ESTRAIBILI DA CINTURA	
17) TASCINO PORTA EROGATORE DA CINTURA	
18) CINTURINO REGOLABILE SU PETTORALE	
19) ELASTICO	
20) CERNIERA	

DATA DI REVISIONE: DICEMBRE 2003
SCALA: 1:125
CODICE: 30010
ARTICOLO: JACKET HI PRO MAX
INDICE DI REVISIONE:

ART.30010 JACKET HI PRO MAX

VALVOLA DI SOVRAPRESSIONE 1c 000004 - O.p. Valve 1.4 nero Ferplast

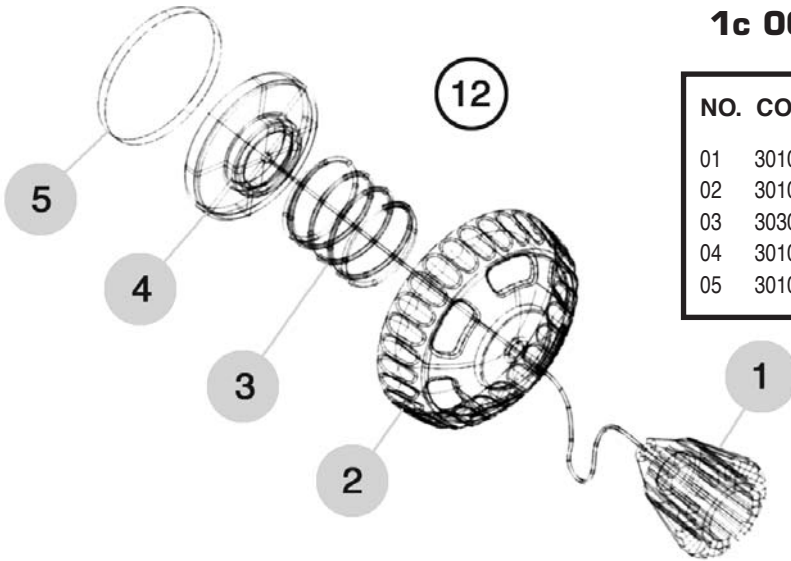

NO.	COD.	DESCRIZIONE	DESCRIPTION
01	301022	POMELLO NERO	PULL BALL BLACK
02	301074	CALOTTA O.P.V.	O.P.V COVER BASE
03	303016	MOLLA PREMIPIATELLO D.1.4	OVERPRESSURE SPRING 1.4
04	301018	PIATTELLO PER VALVOLA	GASKET RETAINER
05	301019	GUARNIZIONE A DISCO	PLATE GASKET

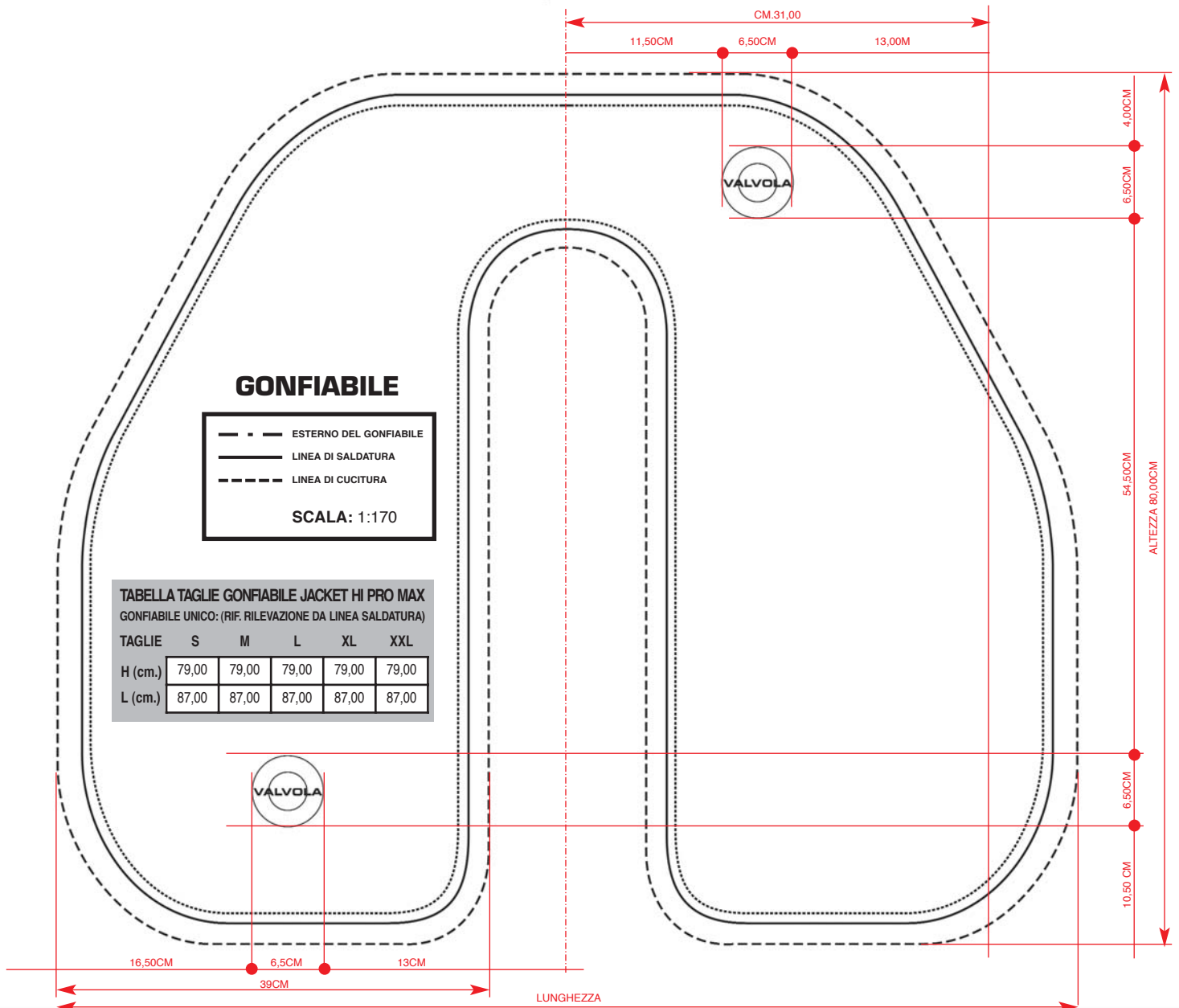

INFLATOR IN - OUT

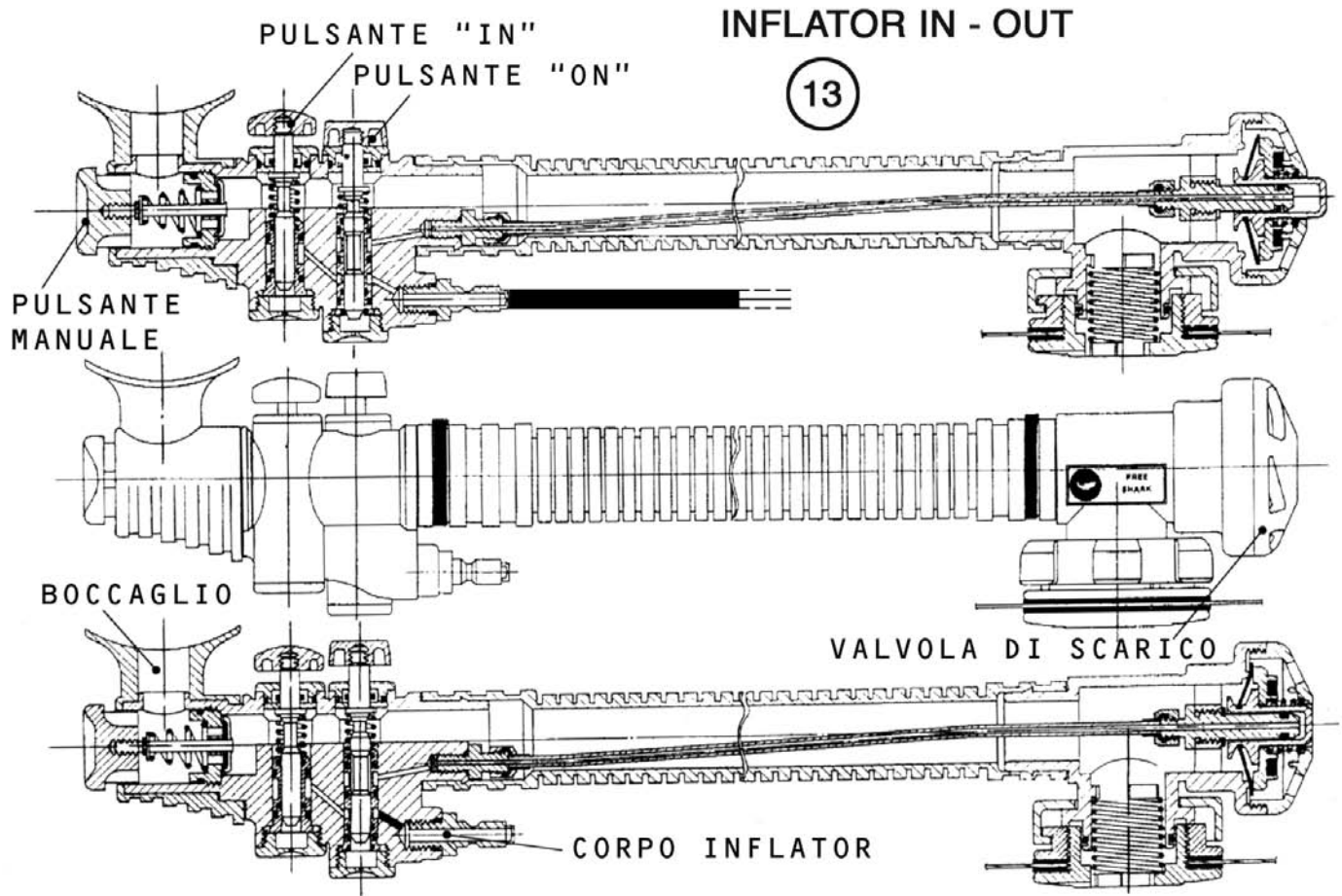

ART.30010 JACKET HI PRO MAX

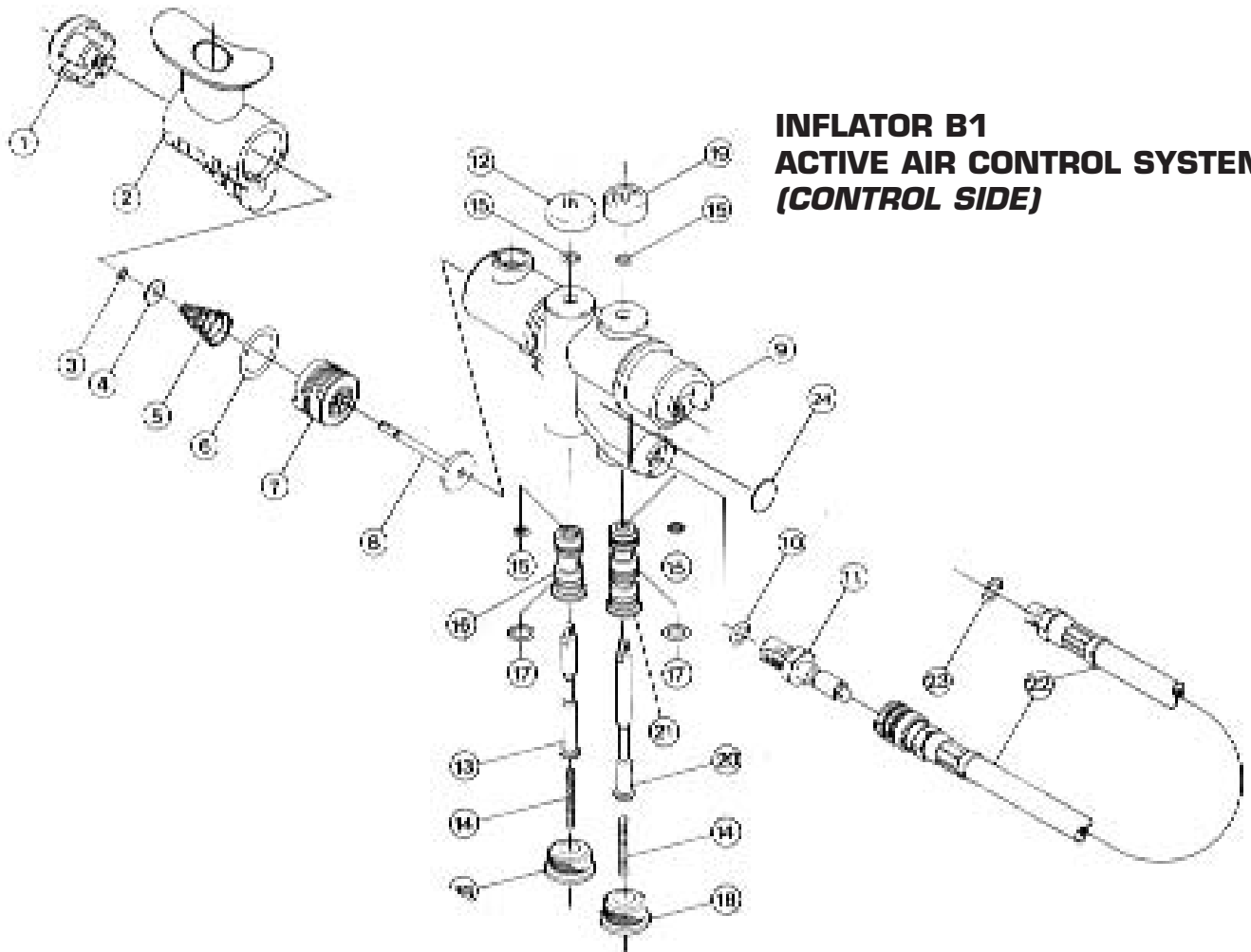

INFLATOR B1 ACTIVE AIR CONTROL SYSTEM (CONTROL SIDE)

NO	PART.NO.	DESCRIZIONE	DESCRIPTION
01	5310200000	Pulsante Valvola a Bocca	Oral Valve Switch
02	5310700000	Boccaglio e Rivestimento	Piece & Cover
03	5030000000	E-Ring ETW-3	E-Ring ETW-3
04	5030200000	Rondella	Washer M4
05	5310600000	Molla valvola a Bocca	Oral Valve Spring
06	5020700000	Guarnizione O-Ring	Jaso -1020
07	5310300000	Flangia per Valvola A Bocca Oral	Valve Flange
08	5006000000	Assemb.Valvola a Bocca	Oral Valve Assy.
09	5310000000	Corpo Comandi	Control Body
10	5010500000	O-Ring P8	O-Ring P8
11	5311700000	Att.Rapido per Tubo Fless.	Plug
12	5310900000	Pulsante "IN"	Inside Switch
13	5311000000	Albero Pulsante IN	Inside Shaft
14	5311600000	Molla per Albero	Cylinder Spring
15	5010300000	O-Ring P8	O-Ring P6
16	5311100000	Sede Albero	Inside Cylinder
17	5010600000	O-Ring P9	O-Ring P9
18	5310800000	Tappo Chiusura	Under Cap
19	5311300000	Pulsante di scarico	Quick Valve Switch
20	5311400000	Albero pulsante "OUT"	Quick Valve Shaft
21	5311500000	Sede Albero	Quick Valve Cylinder
22	5300102000	Frusta Innesto Rapido BP	L.P.Hose Assy.BLK
23	5020200000	O-Ring AN 6227-6	O-Ring AN 6227-6

ART.30010 JACKET HI PRO MAX

INFLATOR B2 ACTIVE AIR CONTROL SYSTEM (VALVE SIDE)

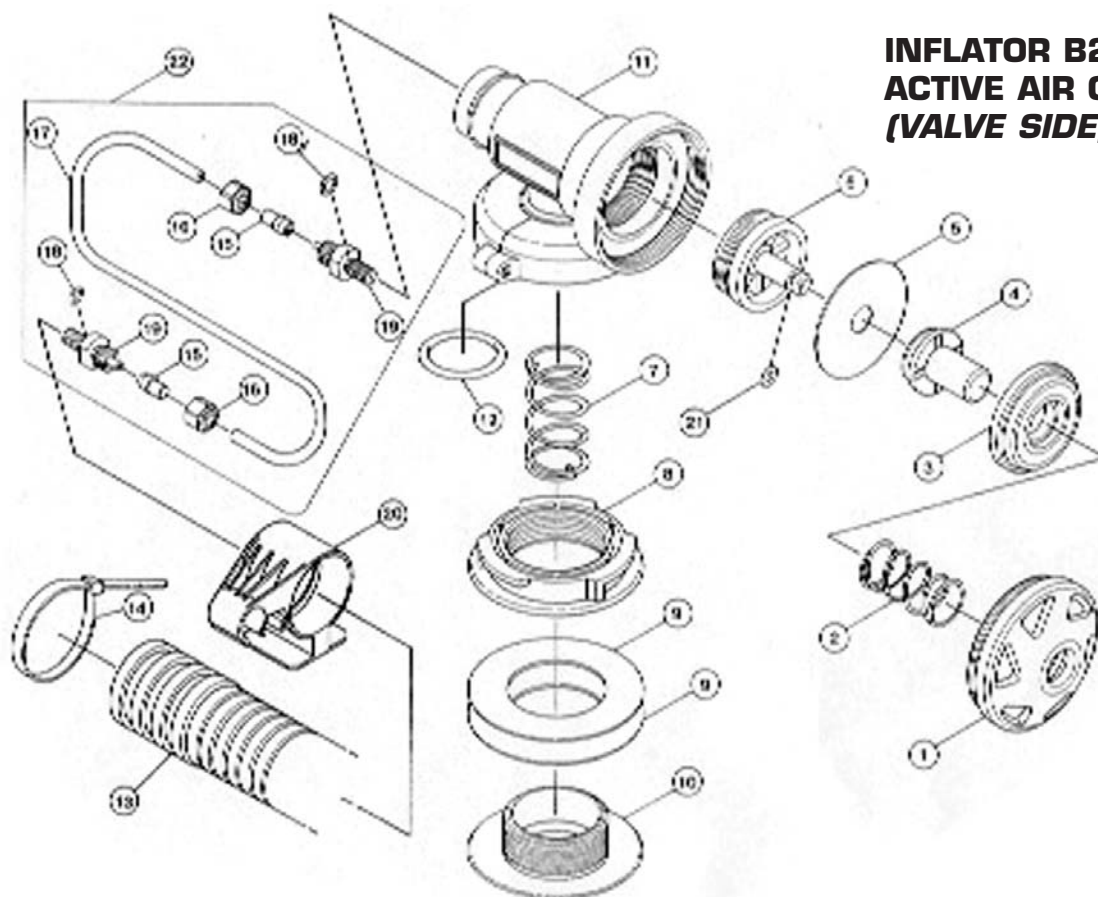

NO	PART.NO.	DESCRIZIONE	DESCRIPTION
01	5311900000	Cappuccio Corpo Valvola	Valve body cap
02	5312500000	Molla di pressione	Pressure spring
03	5300800000	Assembl.Valvola di Pressione	Pressure Valve Assy.
04	5312200000	Pistone della Valvola	Valve Cylinder
05	5312200000	Membrana della Valvola	Valve Sheet.
06	5310100000	Assemb.Corpo Valvola	Shaft & Flange
07	5313200000	O-Ring P5	Base Spring
08	5312900000	Albero e Raccordo filettato	Outer Lock base
09	5313100000	E-Ring ETW-07	Base Packing
10	5313000000	Manicotto	Inner Base
11	5300500000	Dado Bloccaggio	Valve Body (2) Assy.
12	5020900000	Tubo Flessibile	O-Ring Jaso 2025
13	5313300000	Fascetta	Flexible Hose
14	5040001000	Tubo Superiore	Tie Wrap CV200 BLQ
15	5314300000	Raccordo Filettato	Sleeve
16	5314400000	O-Ring S5	Lock Knut
17	5314200000	O-Ring Jaso -2025	Inner Tube 40
18	5015200000	Molla di Base	O-Ring S5
19	5313500000	Bloccaggio Esterno di Base	Nipple
20	5316400000	Rondella di Base	AACS Retainer
21	5010200000	Base Superiore	O-Ring P5
22	5301000000	Tubo d' Innesto-400	Inner Hose Assy 400



BENNY SPORT

via Guerrini, 5

40069 Zola Predosa (Bo) Italy

tel. +39 051 75 36 75

fax +39 051 75 82 28

www.freeshark.it

info@freeshark.it